



Ultrasound Variable-Gain Amplifier

MAX2037

General Description

The MAX2037 8-channel variable-gain amplifier (VGA) is designed for high linearity, high dynamic range, and low-noise performance targeting ultrasound imaging and Doppler applications. Each amplifier features differential inputs and outputs and a total gain range of typically 42dB. In addition, the VGAs offer very low output-referred noise performance suitable for interfacing with 12-bit ADCs.

The MAX2037 VGA is optimized for less than $\pm 0.25\text{dB}$ absolute gain error to ensure minimal channel-to-channel ultrasound beamforming focus error. The device's differential outputs are designed to directly drive ultrasound ADCs through an external passive anti-aliasing filter. A switchable clamp is also provided at each amplifier's outputs to limit the output signals, thereby preventing ADC overdrive or saturation.

Dynamic performance of the device is optimized to reduce distortion to support second-harmonic imaging. The device achieves a second-harmonic distortion specification of -70dBc at $V_{\text{OUT}} = 1.5\text{V}_{\text{P-P}}$ and $f_{\text{IN}} = 5\text{MHz}$, and an ultrasound-specific* two-tone third-order intermodulation distortion specification of -52dBc at $V_{\text{OUT}} = 1.5\text{V}_{\text{P-P}}$ and $f_{\text{IN}} = 5\text{MHz}$.

The MAX2037 operates from a $+5.0\text{V}$ power supply, consuming only $120\text{mW}/\text{channel}$. The device is available in a 100-pin TQFP package with an exposed paddle. Electrical performance is guaranteed over a 0°C to $+70^\circ\text{C}$ temperature range.

Applications

Ultrasound Imaging Sonar

Functional Diagram

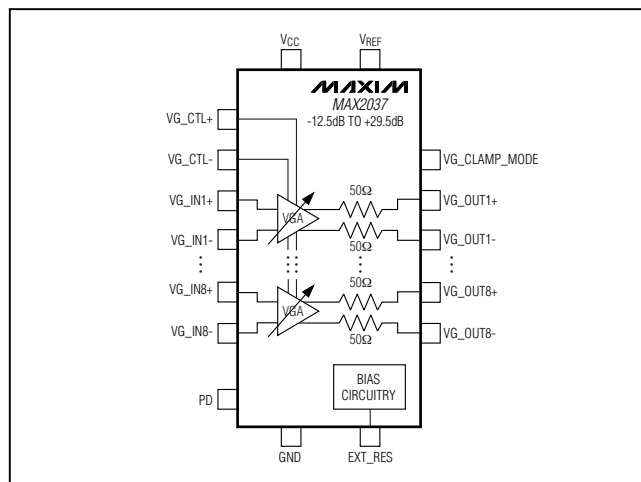

Features

- ◆ 8-Channel Configuration
- ◆ High Integration for Ultrasound Imaging Applications
- ◆ Pin Compatible with the MAX2038 Ultrasound VGA Plus CW Doppler Beamformer
- ◆ Maximum Gain, Gain Range, and Output-Referred Noise Optimized for Interfacing with 12-Bit ADCs
 - Maximum Gain of 29.5dB
 - Total Gain Range of 42dB
 - 22nV/ $\sqrt{\text{Hz}}$ Ultra-Low Output-Referred Noise at 5MHz
 - Pin-for-Pin 10-Bit Compatibility Supported By MAX2035/MAX2036
- ◆ $\pm 0.25\text{dB}$ Absolute Gain Error
- ◆ Switchable Output VGA Clamp Eliminating ADC Overdrive
- ◆ Fully Differential VGA Outputs for Direct ADC Drive
- ◆ Variable Gain Range Achieves 42dB Dynamic Range
- ◆ -70dBc HD2 at $V_{\text{OUT}} = 1.5\text{V}_{\text{P-P}}$ and $f_{\text{IN}} = 5\text{MHz}$
- ◆ Two-Tone Ultrasound-Specific* IMD3 of -52dBc at $V_{\text{OUT}} = 1.5\text{V}_{\text{P-P}}$ and $f_{\text{IN}} = 5\text{MHz}$
- ◆ 120mW Consumption Per Channel

*See the Ultrasound-Specific IMD3 Specification in the Applications Information section.

Ordering Information

| PART | TEMP RANGE | PIN-PACKAGE | PKG CODE |
|---------------|--|-------------------------------|----------|
| MAX2037CCQ-D | 0°C to $+70^\circ\text{C}$ | 100 TQFP-EP† (14mm x 14mm) | C100E-3 |
| MAX2037CCQ-TD | 0°C to $+70^\circ\text{C}$ | 100 TQFP-EP† (14mm x 14mm) | C100E-3 |
| MAX2037CCQ+D | 0°C to $+70^\circ\text{C}$ | 100 TQFP-EP† (14mm x 14mm) | C100E-3 |
| MAX2037CCQ+TD | 0°C to $+70^\circ\text{C}$ | 100 TQFP-EP† (14mm x 14mm) | C100E-3 |

†EP = Exposed paddle.

+ Denotes lead-free package.

T = Tape-and-reel package.

D = Dry packing.



Ultrasound Variable-Gain Amplifier

ABSOLUTE MAXIMUM RATINGS

V_{CC}, V_{REF} to GND-0.3V to +5.5V
 Any Other Pins to GND.....-0.3V to (V_{CC} + 0.3V)
 VGA Differential Input Voltage (V_{GIN+} - V_{GIN-}).....8.0V_{P-P}
 Analog Gain-Control Input Differential Voltage
 (V_{G_CTL+} - V_{G_CTL-}).....8.0V_{P-P}
 Continuous Power Dissipation (T_A = +70°C)
 100-Pin TQFP
 (derated 45.5mW/°C above +70°C).....3636.4mW

Operating Temperature Range.....0°C to +70°C
 Junction Temperature.....+150°C
 θ_{JC}+2°C/W
 θ_{JA}+22°C/W
 Storage Temperature Range.....-40°C to +150°C
 Lead Temperature (soldering, 10s).....+300°C

Stresses beyond those listed under "Absolute Maximum Ratings" may cause permanent damage to the device. These are stress ratings only, and functional operation of the device at these or any other conditions beyond those indicated in the operational sections of the specifications is not implied. Exposure to absolute maximum rating conditions for extended periods may affect device reliability.

DC ELECTRICAL CHARACTERISTICS

(Figure 2, V_{CC} = V_{REF} = 4.75V to 5.25V, T_A = 0°C to +70°C, GND = 0V, PD = 0, no RF signals applied, capacitance to GND at each of the VGA differential outputs is 60pF, differential capacitance across the VGA outputs is 10pF, R_L = 1kΩ. Typical values are at V_{CC} = V_{REF} = 5V, T_A = +25°C, unless otherwise noted.) (Note 1)

| PARAMETER | SYMBOL | CONDITIONS | MIN | TYP | MAX | UNITS |
|--|------------------|--|------|-----|------|------------------|
| Supply Voltage Range | V _{CC} | | 4.75 | 5 | 5.25 | V |
| V _{CC} External Reference Voltage Range | V _{REF} | (Note 2) | 4.75 | 5 | 5.25 | V |
| Total Power Supply Current | | Refers to V _{CC} supply current plus V _{REF} current | | 204 | 231 | mA |
| | | | | 27 | 33 | |
| V _{CC} Supply Current | I _{VCC} | | | 192 | 216 | mA |
| V _{REF} Current | I _{REF} | | | 12 | 15 | mA |
| Current Consumption per Amplifier Channel | | Refers to V _{CC} supply current | | 24 | 27 | mA |
| Differential Analog Control Voltage Range | | Minimum gain | | +2 | | V _{P-P} |
| | | Maximum gain | | -2 | | |
| Differential Analog Control Common-Mode Voltage | V _{CM} | | 2.85 | 3.0 | 3.15 | V |
| Analog Control Input Source/Sink Current | | | | 4.5 | 5 | mA |
| LOGIC INPUTS | | | | | | |
| CMOS Input High Voltage | V _{IH} | | 2.0 | | | V |
| CMOS Input Low Voltage | V _{IL} | | | | 0.8 | V |

Ultrasound Variable-Gain Amplifier

MAX2037

AC ELECTRICAL CHARACTERISTICS

(Figure 2, $V_{CC} = V_{REF} = 4.75V$ to $5.25V$, $V_{CM} = 2.85V$ to $3.15V$, $T_A = 0^\circ C$ to $+70^\circ C$, $GND = 0V$, $PD = 0$, $VG_CLAMP_MODE = 1$, $f_{RF} = 5MHz$, capacitance to GND at each of the VGA differential outputs is $60pF$, differential capacitance across the VGA outputs is $10pF$, $R_L = 1k\Omega$. Typical values are at $V_{CC} = V_{REF} = 5V$, $T_A = +25^\circ C$, unless otherwise noted.) (Note 1)

| PARAMETER | SYMBOL | CONDITIONS | | MIN | TYP | MAX | UNITS |
|--|------------------|--|---|-----|-------|------|--------|
| Full-Scale Bandwidth | f-1.3dB | V _{OUT} = 1.5V _{P-P} , 1.3dB bandwidth, gain = 10dB | Differential output capacitance is 10pF, capacitance to GND at each single-ended output is 60pF, R _L = 1kΩ | | 18 | | MHz |
| | | | No capacitive load R _L = 1kΩ | | 29 | | |
| Small Signal Bandwidth | f-1.3dB | V _{OUT} = 1.5mV _{P-P} , 3dB bandwidth, gain = 10dB | | | 30 | | MHz |
| Differential Input Resistance | R _{IN} | | | 170 | 200 | 230 | Ω |
| Input Effective Capacitance | C _{IN} | f _{RF} = 10MHz, each input to ground | | | 15 | | pF |
| Differential Output Resistance | R _{OUT} | | | | 100 | | Ω |
| Maximum Gain | | | | | +29.5 | | dB |
| Minimum Gain | | | | | -12.5 | | dB |
| Gain Range | | | | | 42 | | dB |
| Absolute Gain Error | | T _A = +25°C, full gain range 0% to 100% | | | ±0.25 | ±1.0 | dB |
| VGA Gain Response Time | | 40dB gain change to within 1dB final value | | | 1 | | μs |
| Input-Referred Noise | | VG_CTL set for maximum gain, no input signal | | | 2 | | nV/√Hz |
| Output-Referred Noise | | VG_CTL set for +10dB of gain | No input signal | | 22 | | nV/√Hz |
| | | | V _{OUT} = 1.5V _{P-P} , 1kHz offset | | 55 | | |
| Second Harmonic | HD2 | VG_CLAMP_MODE = 1, VG_CTL set for +10dB of gain, f _{RF} = 5MHz, V _{OUT} = 1.5V _{P-P} | | | -70 | | dBc |
| | | VG_CLAMP_MODE = 1, VG_CTL set for +10dB of gain, f _{RF} = 10MHz, V _{OUT} = 1.5V _{P-P} | | -55 | -65 | | |
| Third-Order Intermodulation Distortion | IMD3 | VG_CLT set for +10dB of gain, f _{RF1} = 5MHz, f _{RF2} = 5.01MHz, V _{OUT} = 1.5V _{P-P} (Note 3) | | -40 | -52 | | dB |

Ultrasound Variable-Gain Amplifier

AC ELECTRICAL CHARACTERISTICS (continued)

(Figure 2, $V_{CC} = V_{REF} = 4.75V$ to $5.25V$, $V_{CM} = 2.85V$ to $3.15V$, $T_A = 0^\circ C$ to $+70^\circ C$, $GND = 0V$, $PD = 0$, $VG_CLAMP_MODE = 1$, $f_{RF} = 5MHz$, capacitance to GND at each of the VGA differential outputs is $60pF$, differential capacitance across the VGA outputs is $10pF$, $R_L = 1k\Omega$. Typical values are at $V_{CC} = V_{REF} = 5V$, $T_A = +25^\circ C$, unless otherwise noted.) (Note 1)

| PARAMETER | SYMBOL | CONDITIONS | MIN | TYP | MAX | UNITS |
|-------------------------------------|--------|---|-----|-----|-----|------------------------|
| Channel-to-Channel Crosstalk | | $V_{OUT} = 1V_{P-P}$ differential, $f_{RF} = 10MHz$, VG_CTL set for $+10dB$ of gain | | -80 | | dB |
| Maximum Output Voltage at Clamp ON | | $VG_CLAMP_MODE = 0$, VG_CTL set for $+20dB$ of gain, $350mV_{P-P}$ differential input | | 2.4 | | V_{P-P} differential |
| Maximum Output Voltage at Clamp OFF | | $VG_CLAMP_MODE = 1$, VG_CTL set for $+20dB$ of gain, $350mV_{P-P}$ differential input | | 2.8 | | V_{P-P} differential |

Note 1: Specifications at $T_A = +25^\circ C$ and $T_A = +70^\circ C$ are guaranteed by production test. Specifications at $T_A = 0^\circ C$ are guaranteed by design and characterization.

Note 2: Noise performance of the device is dependent on the noise contribution from the supply to V_{REF} . Use a low noise supply for V_{REF} . V_{CC} and V_{REF} can be connected together to share the same supply voltage if the supply for V_{CC} exhibits low noise.

Note 3: See the *Ultrasound-Specific IMD3 Specification* in the *Applications Information* section.

Typical Operating Characteristics

(Figure 2, $V_{CC} = V_{REF} = 4.75V$ to $5.25V$, $GND = 0V$, $PD = 0$, $VG_CLAMP_MODE = 1$, $f_{RF} = 5MHz$, capacitance to GND at each of the VGA differential outputs is $60pF$, differential capacitance across the VGA outputs is $10pF$, $R_L = 1k\Omega$, $T_A = 0^\circ C$ to $+70^\circ C$. Typical values are at $V_{CC} = V_{REF} = 5V$, $T_A = +25^\circ C$, unless otherwise noted.)

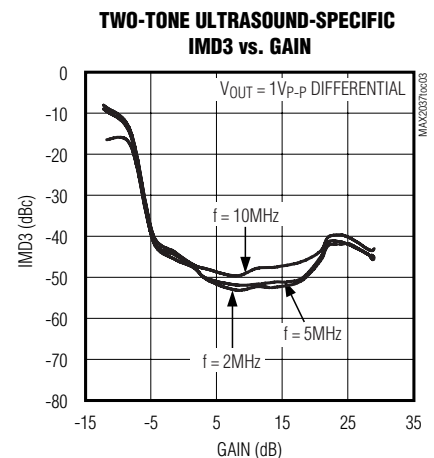
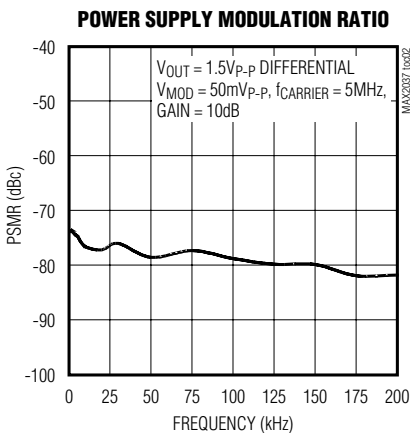
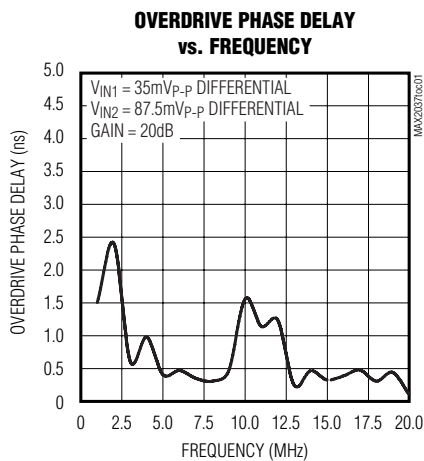

Ultrasound Variable-Gain Amplifier

MAX2037

Typical Operating Characteristics (continued)

(Figure 2, $V_{CC} = V_{REF} = 4.75V$ to $5.25V$, $GND = 0V$, $PD = 0$, $VG_CLAMP_MODE = 1$, $f_{RF} = 5MHz$, capacitance to GND at each of the VGA differential outputs is $60pF$, differential capacitance across the VGA outputs is $10pF$, $R_L = 1k\Omega$, $T_A = 0^\circ C$ to $+70^\circ C$. Typical values are at $V_{CC} = V_{REF} = 5V$, $T_A = +25^\circ C$, unless otherwise noted.)

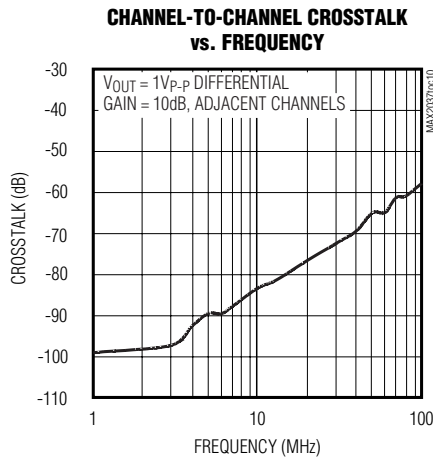
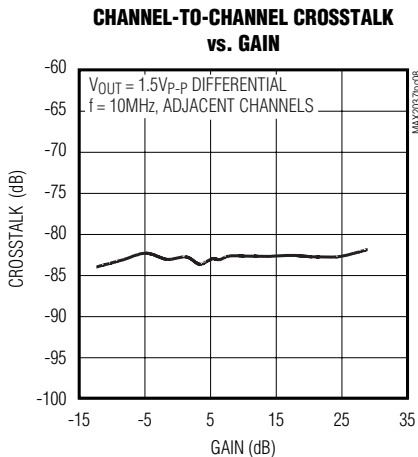
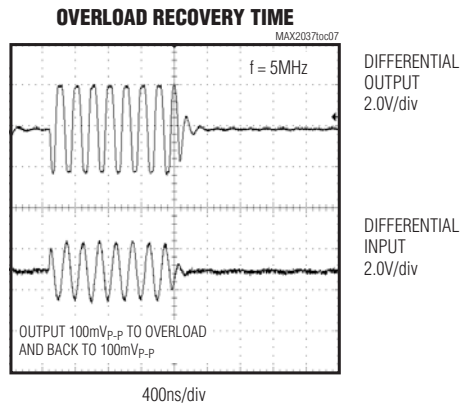
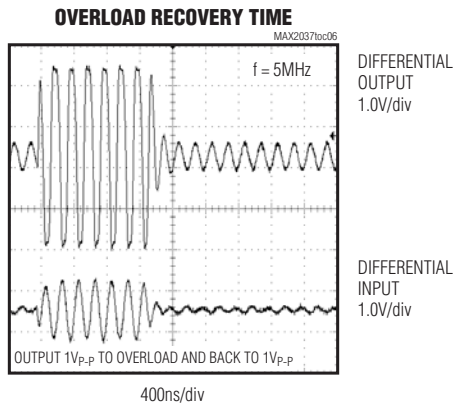
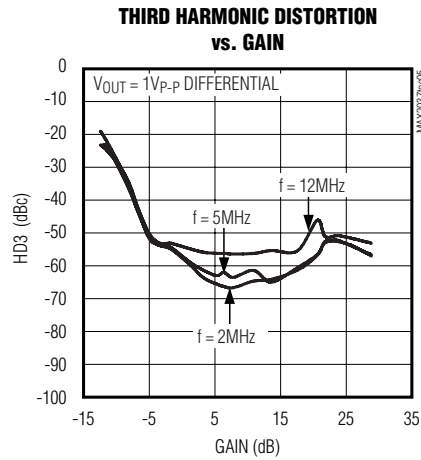
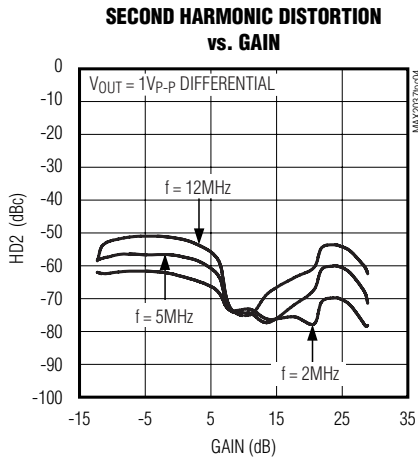

Ultrasound Variable-Gain Amplifier

Typical Operating Characteristics (continued)

(Figure 2, $V_{CC} = V_{REF} = 4.75V$ to $5.25V$, $GND = 0V$, $PD = 0$, $VG_CLAMP_MODE = 1$, $f_{RF} = 5MHz$, capacitance to GND at each of the VGA differential outputs is $60pF$, differential capacitance across the VGA outputs is $10pF$, $R_L = 1k\Omega$, $T_A = 0^\circ C$ to $+70^\circ C$. Typical values are at $V_{CC} = V_{REF} = 5V$, $T_A = +25^\circ C$, unless otherwise noted.)

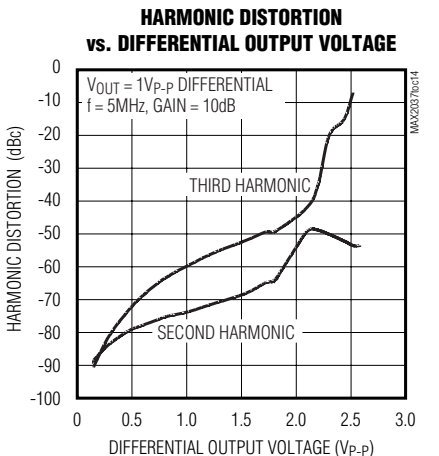
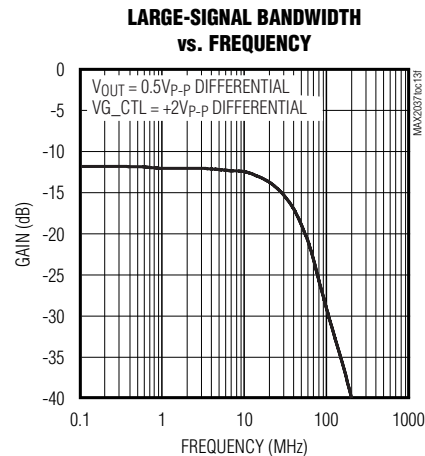
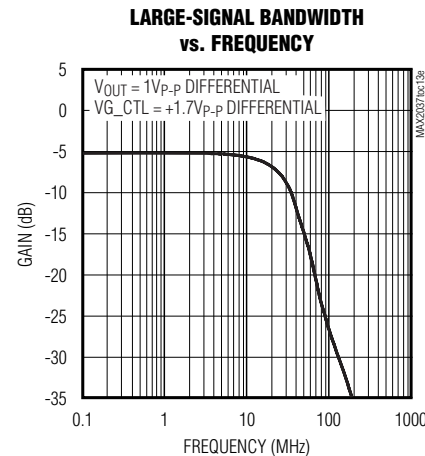
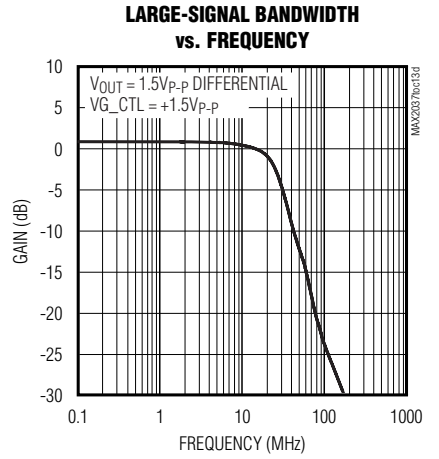
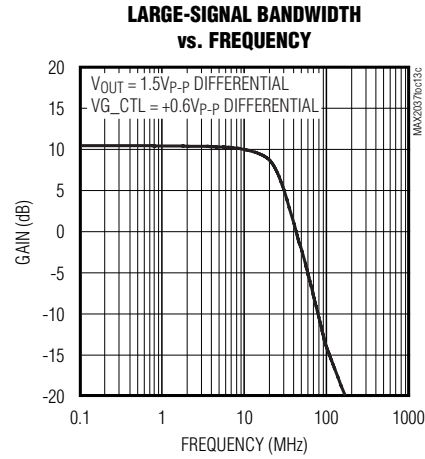
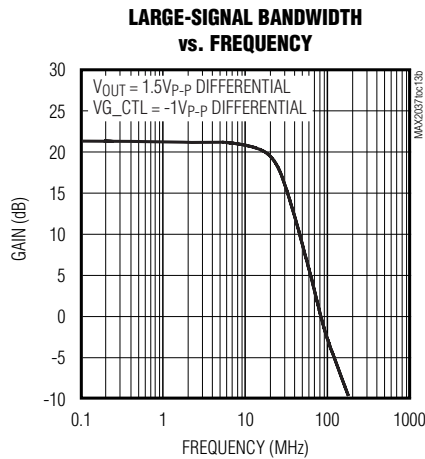
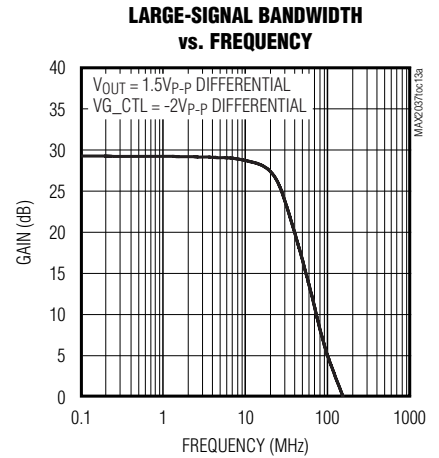
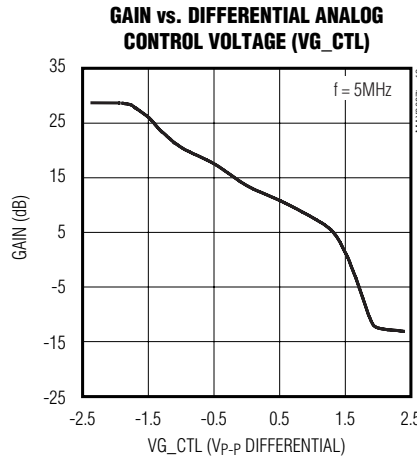
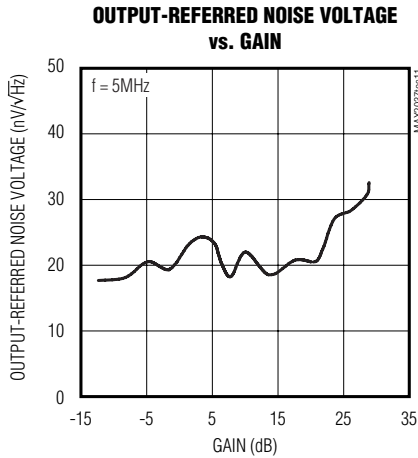

Ultrasound Variable-Gain Amplifier

MAX2037

Typical Operating Characteristics (continued)

(Figure 2, $V_{CC} = V_{REF} = 4.75V$ to $5.25V$, $GND = 0V$, $PD = 0$, $VG_CLAMP_MODE = 1$, $f_{RF} = 5MHz$, capacitance to GND at each of the VGA differential outputs is $60pF$, differential capacitance across the VGA outputs is $10pF$, $R_L = 1k\Omega$, $T_A = 0^\circ C$ to $+70^\circ C$. Typical values are at $V_{CC} = V_{REF} = 5V$, $T_A = +25^\circ C$, unless otherwise noted.)

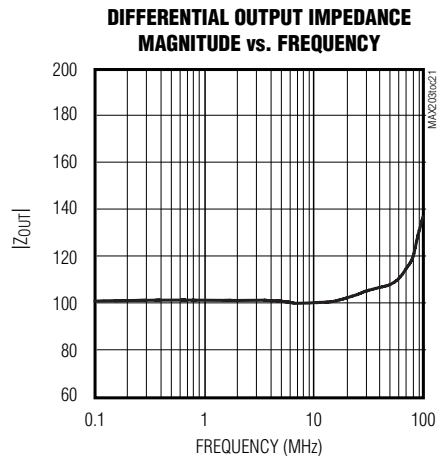
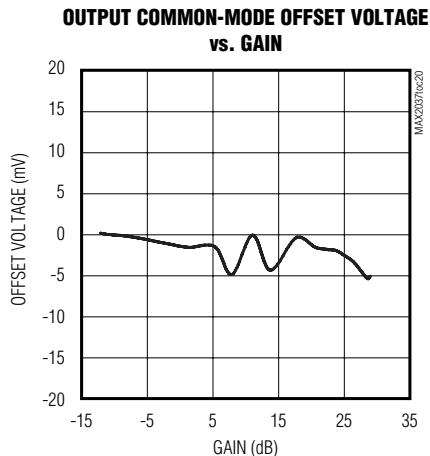
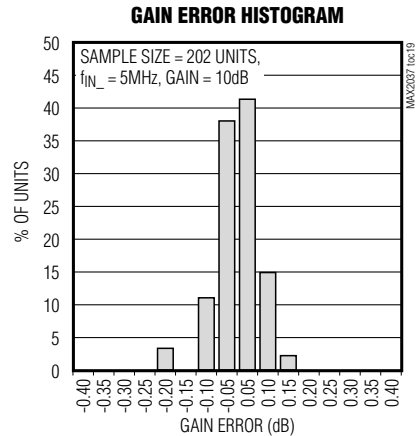
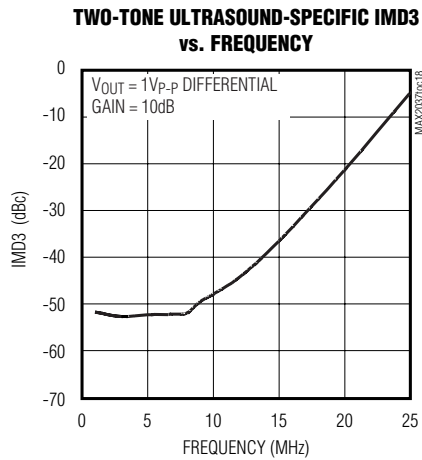
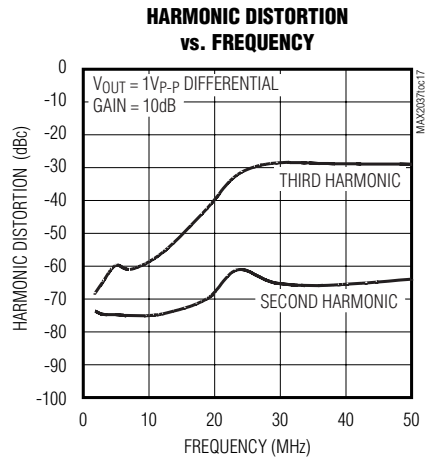
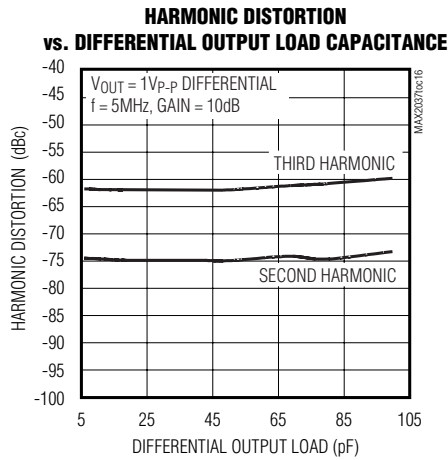
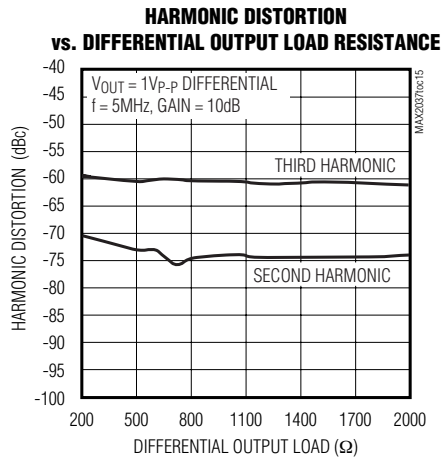

Ultrasound Variable-Gain Amplifier

Pin Description

| PIN | NAME | FUNCTION |
|--|---------|--|
| 1, 2, 5, 6, 7, 10, 11, 12, 19, 20, 21, 24, 25, 26, 29, 30, 31, 34, 35, 36, 41, 43, 44, 45, 47, 48, 51, 55, 58, 59, 64, 65, 66, 69, 73, 76, 79, 80, 81, 83, 84, 85, 88–92, 96, 97, 98 | GND | Ground |
| 3 | VGIN3- | VGA Channel 3 Inverting Differential Input |
| 4 | VGIN3+ | VGA Channel 3 Noninverting Differential Input |
| 8 | VGIN4- | VGA Channel 4 Inverting Differential Input |
| 9 | VGIN4+ | VGA Channel 4 Noninverting Differential Input |
| 13 | EXT_C1 | External Compensation. Connect a 4.7 μ F capacitor to ground. |
| 14 | EXT_C2 | External Compensation. Connect a 4.7 μ F capacitor to ground. |
| 15 | EXT_C3 | External Compensation. Connect a 4.7 μ F capacitor to ground. |
| 16, 39, 42, 46, 54, 72, 82, 87 | VCC | 5V Power Supply. Bypass each VCC supply to ground with 0.1 μ F capacitors as close to the pins as possible. |
| 17 | VGIN5- | VGA Channel 5 Inverting Differential Input |
| 18 | VGIN5+ | VGA Channel 5 Noninverting Differential Input |
| 22 | VGIN6- | VGA Channel 6 Inverting Differential Input |
| 23 | VGIN6+ | VGA Channel 6 Noninverting Differential Input |
| 27 | VGIN7- | VGA Channel 7 Inverting Differential Input |
| 28 | VGIN7+ | VGA Channel 7 Noninverting Differential Input |
| 32 | VGIN8- | VGA Channel 8 Inverting Differential Input |
| 33 | VGIN8+ | VGA Channel 8 Noninverting Differential Input |
| 37, 93 | VREF | 5V Reference Supply. Bypass to GND with a 0.1 μ F capacitor as close to the pins as possible. Note that noise performance of the device is dependent on the noise contribution from the supply to VREF. Use a low noise supply for VREF. VCC and VREF can be connected together to share the same supply voltage if the supply for VCC exhibits low noise. |
| 38 | EXT_RES | External Resistor. Connect a 7.5k Ω resistor to ground. |
| 40 | PD | Power-Down Switch. Drive PD high to set the device in power-down mode. Drive PD low for normal operation. |
| 49 | VGOUT8+ | VGA Channel 8 Noninverting Differential Output |
| 50 | VGOUT8- | VGA Channel 8 Inverting Differential Output |
| 52 | VGOUT7+ | VGA Channel 7 Noninverting Differential Output |
| 53 | VGOUT7- | VGA Channel 7 Inverting Differential Output |
| 56 | VGOUT6+ | VGA Channel 6 Noninverting Differential Output |
| 57 | VGOUT6- | VGA Channel 6 Inverting Differential Output |
| 60 | VGOUT5+ | VGA Channel 5 Noninverting Differential Output |

Ultrasound Variable-Gain Amplifier

MAX2037

Pin Description (continued)

| PIN | NAME | FUNCTION |
|-----|---------------|--|
| 61 | VGOUT5- | VGA Channel 5 Inverting Differential Output |
| 62 | VG_CTL- | VGA Analog Gain-Control Inverting Input |
| 63 | VG_CTL+ | VGA Analog Gain-Control Noninverting Input |
| 67 | VGOUT4+ | VGA Channel 4 Noninverting Differential Output |
| 68 | VGOUT4- | VGA Channel 4 Inverting Differential Output |
| 70 | VGOUT3+ | VGA Channel 3 Noninverting Differential Output |
| 71 | VGOUT3- | VGA Channel 3 Inverting Differential Output |
| 74 | VGOUT2+ | VGA Channel 2 Noninverting Differential Output |
| 75 | VGOUT2- | VGA Channel 2 Inverting Differential Output |
| 77 | VGOUT1+ | VGA Channel 1 Noninverting Differential Output |
| 78 | VGOUT1- | VGA Channel 1 Inverting Differential Output |
| 86 | VG_CLAMP_MODE | VGA Clamp Mode Enable. Drive VG_CLAMP_MODE low to enable VGA clamping. VGA output will be clamped at typically 2.4V _{P-P} differential. Drive VG_CLAMP_MODE high to disable VGA clamp mode. |
| 94 | VGIN1- | VGA Channel 1 Inverting Differential Input |
| 95 | VGIN1+ | VGA Channel 1 Noninverting Differential Input |
| 99 | VGIN2- | VGA Channel 2 Inverting Differential Input |
| 100 | VGIN2+ | VGA Channel 2 Noninverting Differential Input |
| — | EP | Exposed paddle. Solder the exposed paddle to the ground plane using multiple vias. |

Detailed Description

The MAX2037's VGAs are optimized for high linearity, high dynamic range, and low output noise performance, making this component ideal for ultrasound-imaging applications. The VGA paths also exhibit a channel-to-channel crosstalk of -80dB at 10MHz and an absolute gain error of less than ± 0.25 dB for minimal channel-to-channel focusing error in an ultrasound system. Each VGA path includes circuitry for adjusting analog gain, an output buffer with differential output ports (VGOUT₊, VGOUT₋) for driving ADCs, and differential input ports (VGIN₊, VGIN₋) that are ideal for directly interfacing to the MAX2034 quad LNA. See the *Functional Diagram* for details.

The VGA has an adjustable gain range from -12.5dB to +29.5dB, achieving a total dynamic range of typically 42dB. The VGA gain can be adjusted with the differential gain-control input VG_CTL+ and VG_CTL-. Set the differential gain-control input voltage at -2V for maximum gain and +2V for minimum gain. The differential analog control common-mode voltage is typically 3.0V.

VGA Clamp

A clamp is provided to limit the VGA output signals to avoid overdriving the ADC or to prevent ADC saturation. Set VG_CLAMP_MODE low to clamp the VGA differential outputs at 2.4V_{P-P}. Set the VG_CLAMP_MODE high to disable the clamp.

Power Down

The device can also be powered down with PD. Set PD to logic-high for power-down mode. In power-down mode, the device draws a total supply current of 27mA. Set PD to a logic-low for normal operation.

Overload Recovery

The device is also optimized for quick overload recovery for operation under the large input signal conditions that are typically found in ultrasound input buffer imaging applications. See the *Typical Operating Characteristics* for an illustration of the rapid recovery time from a transmit-related overload.

Ultrasound Variable-Gain Amplifier

Applications Information

External Compensation

External compensation is required for bypassing internal biasing circuitry. Connect, as close as possible, individual 4.7 μ F capacitors from each pin EXT_C1, EXT_C2, and EXT_C3 (pin 13, 14, 15) to ground.

External Bias Resistor

An external resistor at EXT_RES is required to set the bias for the internal biasing circuitry. Connect, as close as possible, a 7.5k Ω resistor from EXT_RES (pin 38) to ground.

Analog Input and Output Coupling

In typical applications, the MAX2037 is being driven from a low-noise amplifier (such as the MAX2034) and is typically driving a discrete differential anti-alias filter into an ADC (such as the MAX1436 octal ADC). The differential input impedance of the MAX2037 is typically 200 Ω . The differential outputs are capable of driving a differential load resistance of 1000 Ω . The output impedance is 100 Ω differential. The differential outputs have a common-mode bias of approximately 3.0V. AC-couple these differential outputs if the next stage has a different common-mode input range.

Ultrasound-Specific IMD3 Specification

Unlike typical communications specs, the two input tones are not equal in magnitude for the ultrasound-specific IMD3 two-tone specification. In this measurement, f_1 represents reflections from tissue and f_2 represents reflections from blood. The latter reflections are typically 25dB lower in magnitude, and hence the measurement is defined with one input tone 25dB lower than the other. The IMD3 product of interest ($f_1 - (f_2 - f_1)$) presents itself as an undesired Doppler error signal in ultrasound applications. See Figure 1.

Board Layout

The pin configuration of the MAX2037 is optimized to facilitate a very compact physical layout of the device and its associated discrete components. A typical application for this device might incorporate several devices in close proximity to handle multiple channels of signal processing.

The exposed paddle (EP) of the MAX2037's TQFP-EP package provides a low thermal-resistance path to the die. It is important that the PC board on which the MAX2037 is mounted be designed to conduct heat from the EP. In addition, provide the EP with a low-inductance path to electrical ground. The EP **MUST** be soldered to a ground plane on the PCB, either directly or through an array of plated via holes.

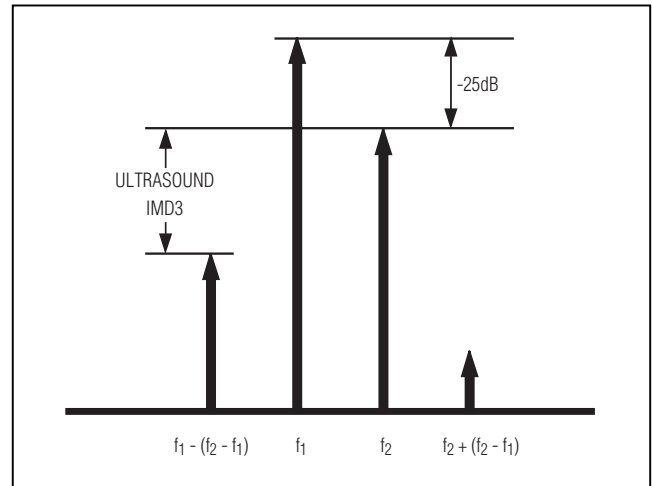

Figure 1. Ultrasound IMD3 Measurement Technique

Ultrasound Variable-Gain Amplifier

MAX2037

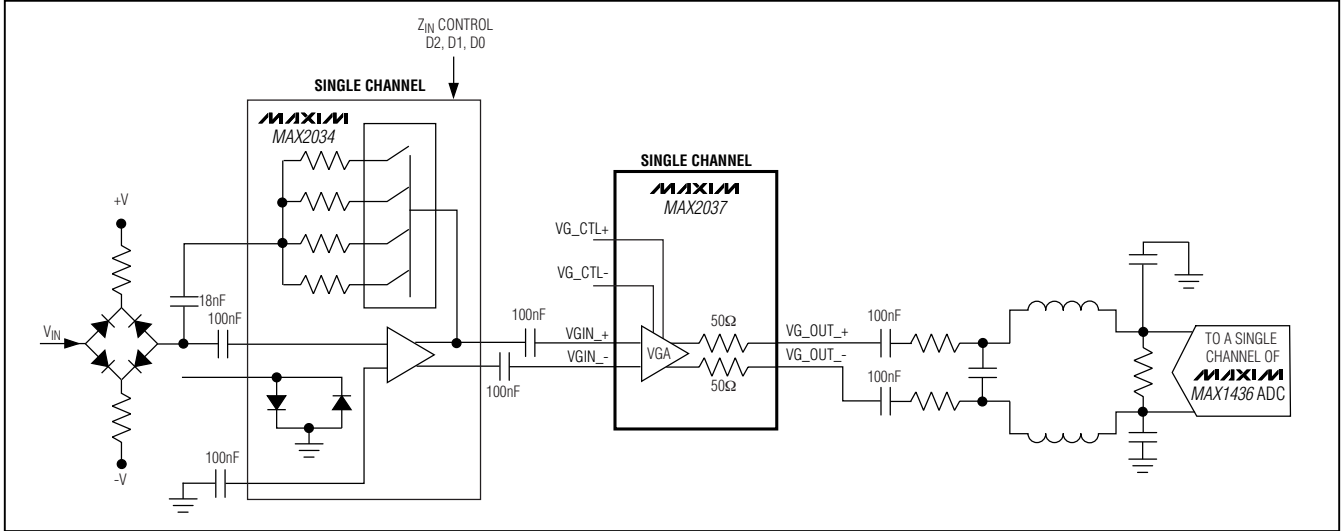
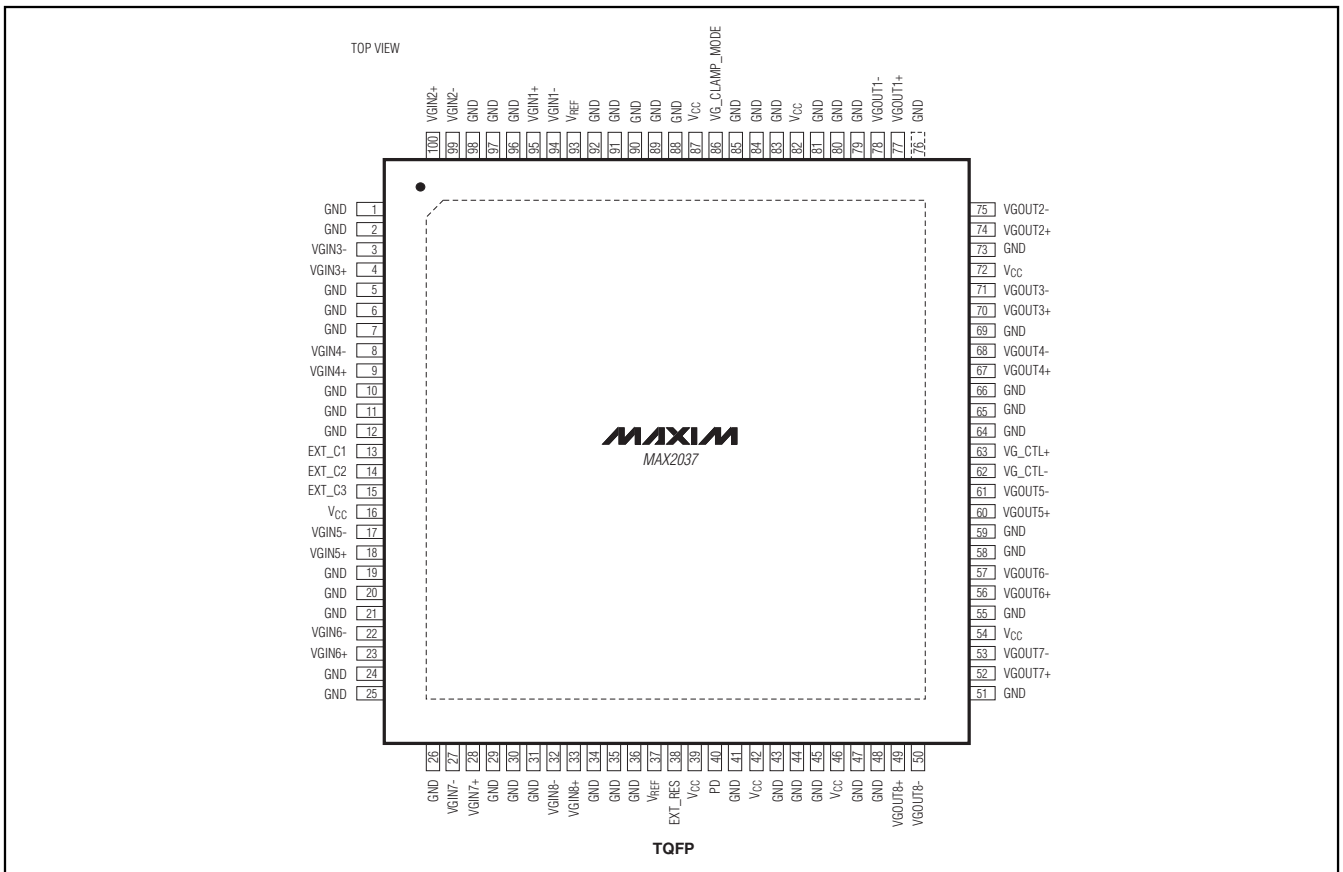

Figure 2. Typical Per-Channel Ultrasound-Imaging Application

Pin Configuration



Ultrasound Variable-Gain Amplifier

Package Information

(The package drawing(s) in this data sheet may not reflect the most current specifications. For the latest package outline information go to www.maxim-ic.com/packages.)

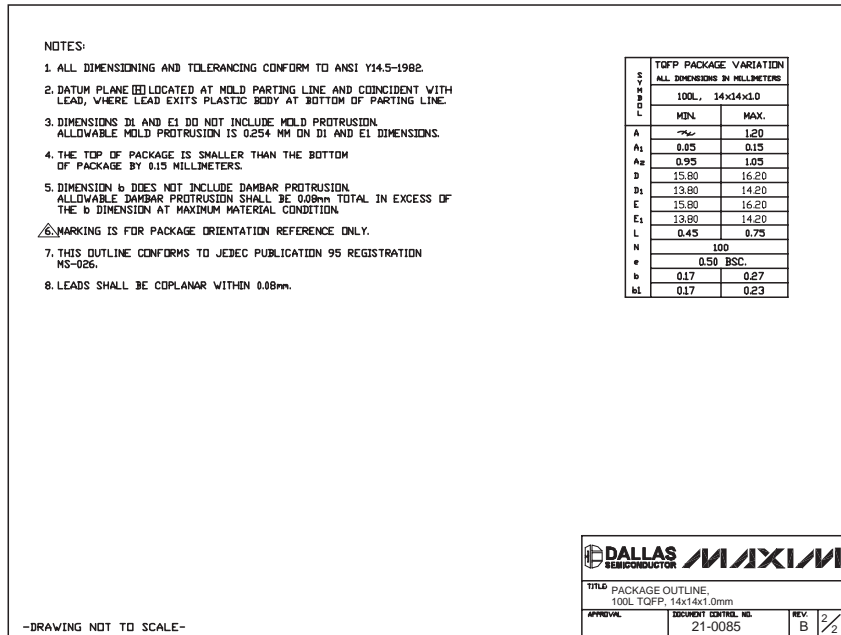
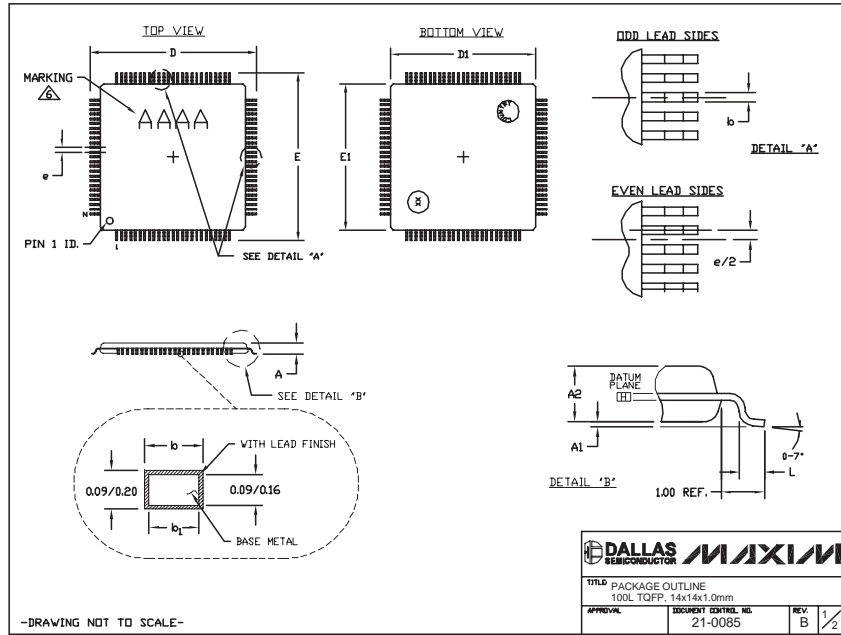

Maxim cannot assume responsibility for use of any circuitry other than circuitry entirely embodied in a Maxim product. No circuit patent licenses are implied. Maxim reserves the right to change the circuitry and specifications without notice at any time.

12 **Maxim Integrated Products, 120 San Gabriel Drive, Sunnyvale, CA 94086 408-737-7600**